







## PRO-60 HP | PORTABLE HYDRAULIC PUNCHERS PRO-110 HP



### Primary features and benefits:

- Double action - fully automated process of punching and return
- Wide range of hole diameters up to 27mm
- Modern construction
- Intelligent control system with inching and automatic load detection
- Mode indicator light
- Protection against accidental start-up
- Easy to handle in out-of-normal positions
- All connecting ports located at the back
- Wide range of special-shaped punches and dies
- Patent pending compact moveable hydraulic power pack
- Unique Gantry Punching Station increases both productivity and operator's comfort



							
	max. thickness	max. throat depth	max. hole	max. oblong hole	punching time	punching power	double action hydraulic movement

PRO 60 HP	13 mm	60 mm	27 mm	25 x 18 mm	5 sec	35 ton	YES
PRO 110 HP	16 mm	110 mm	27 mm	25 x 18 mm	8 sec	47 ton	YES

Portable Double-Action Hydraulic Puncher Technical Specification	model PRO 60 HP	model PRO 110 HP
Max. throat depth	60 mm	110 mm
Max. hole	Ø 27 mm	Ø 27 mm
Max. oblong hole	25 x 18 mm	25 x 18 mm
Punching time	5 sec	8 sec
Max. plate thickness	13 mm	16 mm
Punching power	35 ton	47 ton
Working pressure	700 bar	700 bar
Weight	20 kg	35 kg
Product code	GLW-0522-10-00-00-1	GLW-0507-10-00-00-0

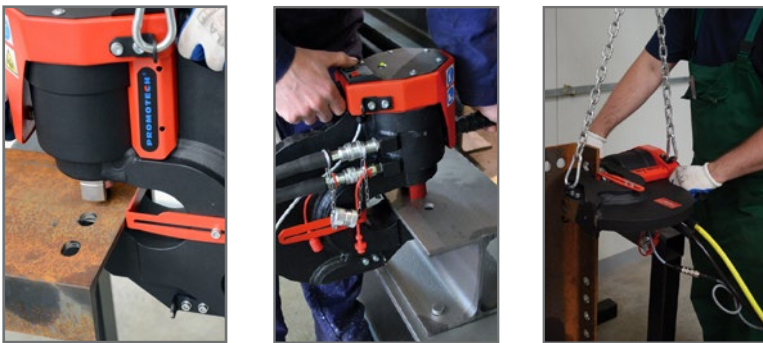

Ready to work in both vertical and horizontal positions

Double-Action Hydraulic Power Pack model HPP 700/1.5	
Power supply*	230V/50Hz; 115V/60Hz
Motor power	1500 W
Working pressure	700 bar
Pump output	1.5 L/min
Oil capacity	10 L
Product code	ZSL-0517-10-20-00-0
	HPP-700/1,5 /220-240V/50Hz

\* Contact Promotech for other voltage options



Portable hydraulic power pack with shelf for puncher transport.



## Dimensions

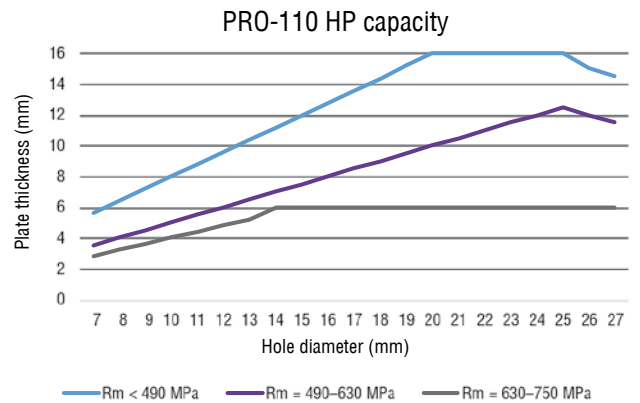
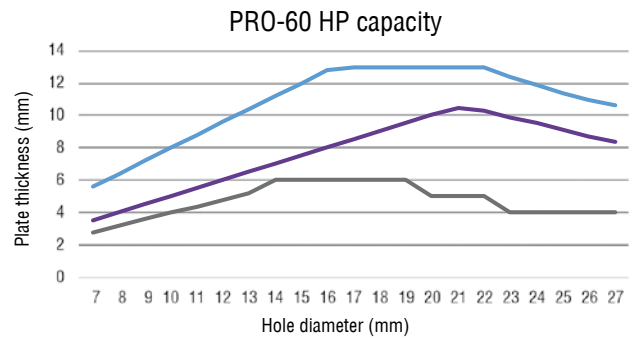
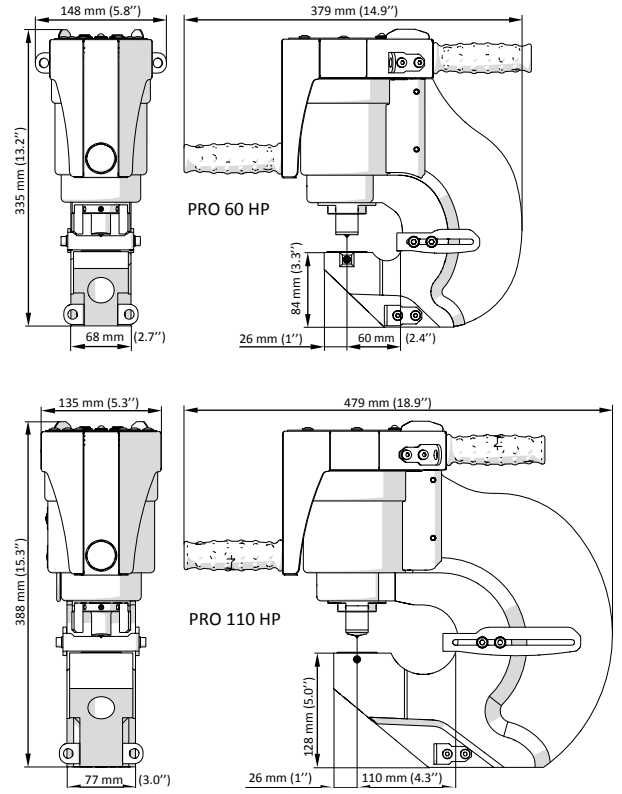

Balancer for PRO 60 HP; Product code: BLN-000004  
Balancer for PRO 110 HP; Product code: BLN-000005



Customize your work place with a variety of optional accessories.

### Hoist set

Product code: ZUR-0517-15-00-00-0



Simple set-up and easy adjustment of height and balance control.



Hoist arm and 2 supports with wheels allow for easy manipulation of punch and power pack as single unit.

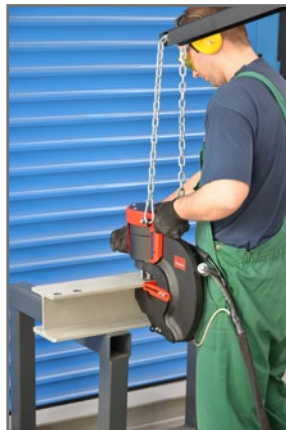

Unique solution which makes your work as efficient and comfortable as never before.

### Wheel puncher slide

Product code: PRW-0507-90-00-00-0

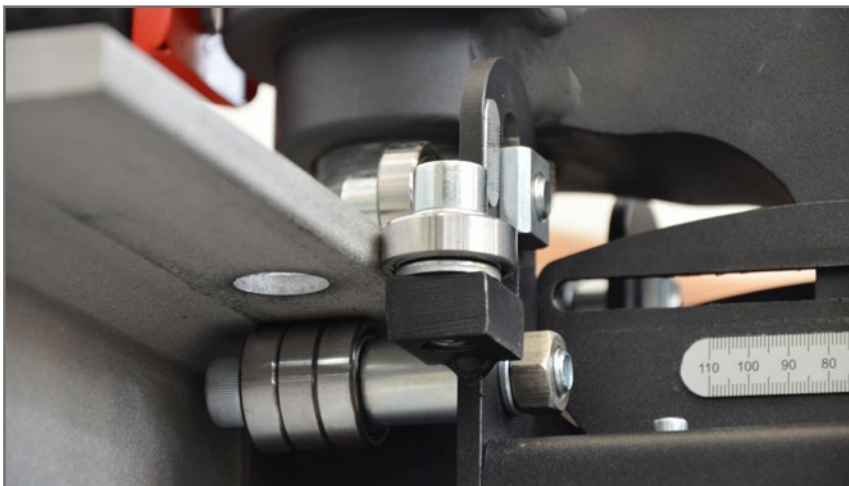

Permits smooth and efficient lineal movement along the workpiece.

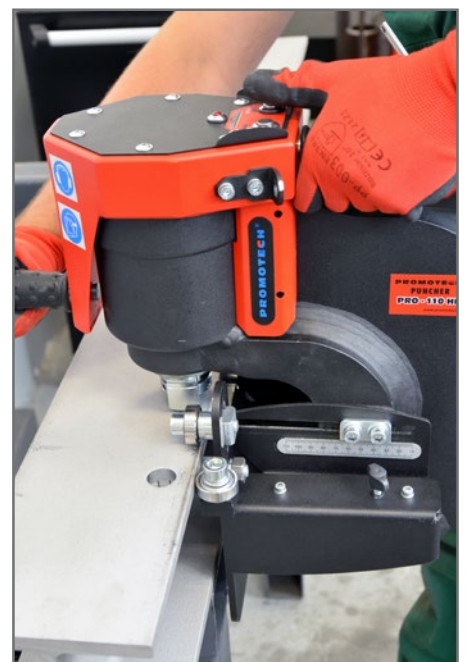

## Bench top stand with foot pedal

Product code: ZST-0507-91-00-00-0



Neither balancer nor hoist arm is required to keep puncher in place.  
An operator can use start and stop buttons on the machine or foot pedals.



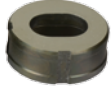

Foot pedal machine control in hands free operation on bench top configuration.

## Punches & dies

Hydraulic Punchers tools		
Oblong [mm]	Punch - product code	Die - product code
16x8	STM-0507-30-13-00-0	MTY-0507-70-13-00-0
18x9	STM-0507-30-12-00-0	MTY-0507-70-12-00-0
18x11	STM-0507-30-11-00-0	MTY-0507-70-11-00-0
20x10	STM-0507-30-10-00-0	MTY-0507-70-10-00-0
20x12	STM-0507-30-09-00-0	MTY-0507-70-09-00-0
20x14	STM-0507-30-08-00-0	MTY-0507-70-08-00-0
22x11	STM-0507-30-07-00-0	MTY-0507-70-07-00-0
22x14	STM-0507-30-06-00-0	MTY-0507-70-06-00-0
24x12	STM-0507-30-05-00-0	MTY-0507-70-05-00-0
25x9	STM-0507-30-04-00-0	MTY-0507-70-04-00-0
25x12	STM-0507-30-03-00-0	MTY-0507-70-03-00-0
25x13	STM-0507-30-02-00-0	MTY-0507-70-02-00-0
25x14	STM-0507-30-01-00-0	MTY-0507-70-01-00-0
25x18	STM-0507-30-00-00-0	MTY-0507-70-00-00-0

Various hydraulic punch tools are available on request in imperial or metric sizes.

Hydraulic Punchers tools			
Diameter [mm]	Punch - product code	Die - product code	Die 5° - product code
7	STM-0507-20-18-00-0	MTY-0507-40-18-00-0	-
8	STM-0507-20-17-00-0	MTY-0507-40-17-00-0	-
9	STM-0507-20-16-00-0	MTY-0507-40-16-00-0	MTY-0507-50-16-00-0
10	STM-0507-20-15-00-0	MTY-0507-40-15-00-0	MTY-0507-50-15-00-0
11	STM-0507-20-14-00-0	MTY-0507-40-14-00-0	MTY-0507-50-14-00-0
12	STM-0507-20-13-00-0	MTY-0507-40-13-00-0	MTY-0507-50-13-00-0
13	STM-0507-20-12-00-0	MTY-0507-40-12-00-0	MTY-0507-50-12-00-0
14	STM-0507-20-11-00-0	MTY-0507-40-11-00-0	MTY-0507-50-11-00-0
15	STM-0507-20-10-00-0	MTY-0507-40-10-00-0	MTY-0507-50-10-00-0
16	STM-0507-20-09-00-0	MTY-0507-40-09-00-0	MTY-0507-50-09-00-0
17	STM-0507-20-08-00-0	MTY-0507-40-08-00-0	MTY-0507-50-08-00-0
18	STM-0507-20-07-00-0	MTY-0507-40-07-00-0	MTY-0507-50-07-00-0
19	STM-0507-20-06-00-0	MTY-0507-40-06-00-0	MTY-0507-50-06-00-0
20	STM-0507-20-05-00-0	MTY-0507-40-05-00-0	MTY-0507-50-05-00-0
21	STM-0507-20-04-00-0	MTY-0507-40-04-00-0	MTY-0507-50-04-00-0
22	STM-0507-20-03-00-0	MTY-0507-40-03-00-0	MTY-0507-50-03-00-0
23	STM-0507-20-02-00-0	MTY-0507-40-02-00-0	MTY-0507-50-02-00-0
24	STM-0507-20-01-00-0	MTY-0507-40-01-00-0	MTY-0507-50-01-00-0
25	STM-0507-20-00-00-0	MTY-0507-40-00-00-0	MTY-0507-50-00-00-0
26	STM-0507-20-19-00-0	MTY-0507-40-19-00-0	MTY-0507-50-19-00-0
27	STM-0507-20-20-00-0	MTY-0507-40-20-00-0	MTY-0507-50-20-00-0

All information is subject to change without notice. 1708



PROMOTECH Sp. z o.o.  
ul. Elewatorska 23/1, 15-620 BIAŁYSTOK, POLAND  
tel. (+48 85) 678 34 05, fax (+48 85) 662 78 77  
marketing@promotech.eu www.promotech.eu

Your local dealer:

